

Контроллер SR-EUR0420 (220V, 4x20A, DALI, DMX)



Summary

Thanks for using our relay switch controller. The product adopts advanced microcomputer control technology, analysis widely used DMX-512 (1990) /RDM, DALI standard protocol, output 4 relay switch signal and their synchronous 0-10V DC control signal. The max current of each channel of relay switch is 20A, the total 4 channel is 80A, the max current of each channel of 0-10V is 20mA. In addition, the device can be connected into the Dynalite system by the Dynalite gateway (Note: the Dynalite trademark holder is PHILIPS, the relevant right is owned by the holder of the trademark, the same below)

Product Features

- Meets DMX512(1990)/RDM, DALI IEC62386 protocol
- Output 4 channel relay switch signal and their synchronous DC 0-10V control signal
- Built-in LCD, the user can operate more conveniently
- Set fades time of each channel separately, range of 0.1-60.9s
- Standard 35 mm din rail, convenient installation
- Relay switch channel can be turned on and off manually
- Can save up to 8 events
- Suitable for intelligent lighting control - Home Furnishing, office buildings, schools, stadiums, outdoor architecture etc.

Technical Parameters

Item	Parameters
Input voltage	100-240VAC 50/60Hz
Input control signal	DMX512(1990)/RDM,DALI
Maximum output current of relay switch channel	20A*4ch
Maximum output signal current of 0-10V	20mA*4ch
Dimension	167*93.4*63.2mm(L*W*H),standard 35mm din rail
Pack size	185*100*68mm(L*W*H)
G.W.	580g
Operational temperature	-20-40°C

Dimension(mm)

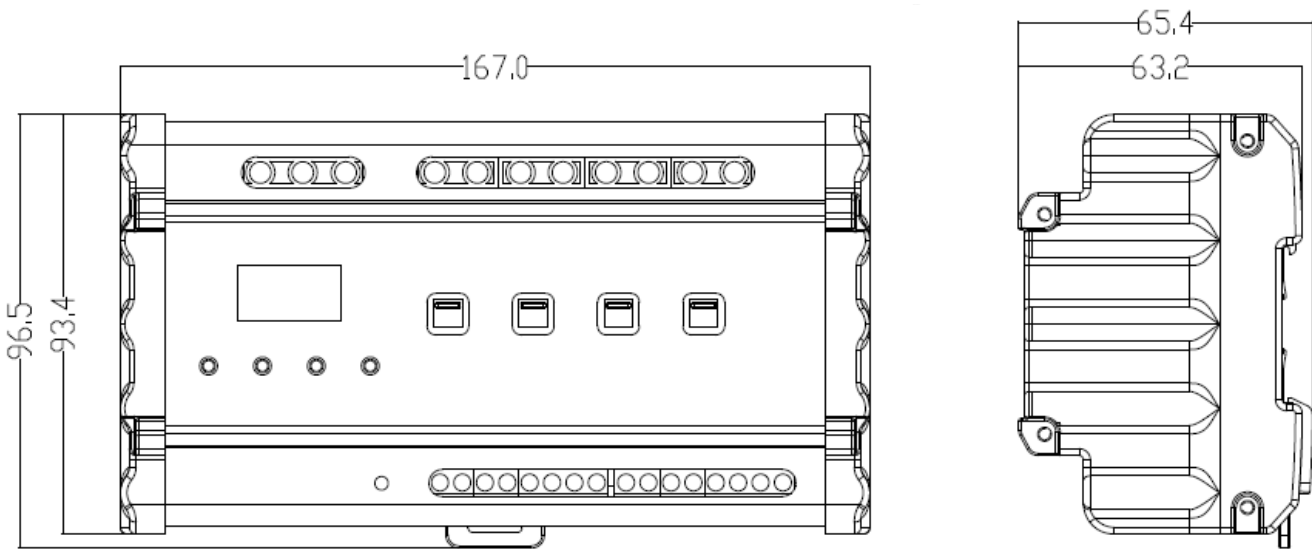

Function Show of the product

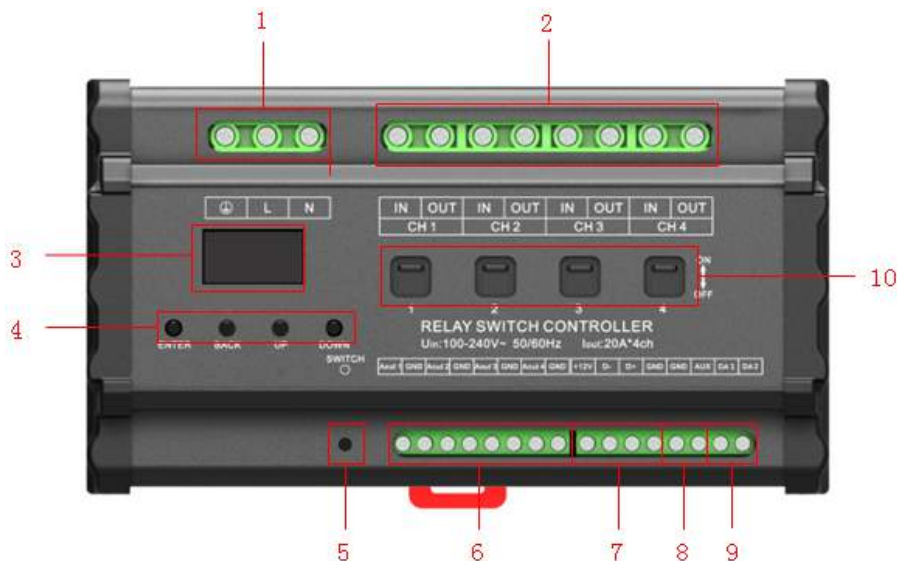

Figure 1

1	AC input port
2	4 relay switch output ports, corresponding with 4 DC 0-10 V ports of 6 from left to right in proper order. For each channel, both the addresses of relay switch signal and the corresponding 0-10V are shared.
3	LCD display
4	Function button
	Button, Press 1 time: the device report its own serial number information; Press 3 times continuously: all the channels have output; Press for 4s or more: the device is reset and restarted
8	4 DC analog voltage output ports(0-10V)
	DMX 512/RDM input port and 12 V output port
	Input signal of dry contact, used for detecting external signals, and triggering device to response
	DALI signal input&output port
10	Manual switch

LCD Function

After a successful connection, the main menu will be seen,including control mode, output mode, time event, system settings and system information,see figure 2 and figure 3. Press the button "Enter" to enter the sub menu press "BACK" to return to the upper menu, press "Up" or "Down" button to move the cursor up or down.

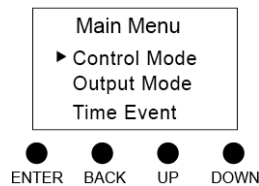

Figure 2

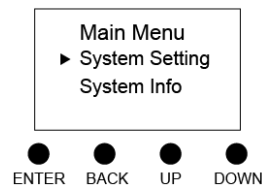

Figure 3

Button	Function
ENTER	Confirm key, confirm the selected state,enter the option to set the state
BACK	Return key, return to the upper menu,exit the option to set the state
UP	Move up the cursor; change the status of the option; when setting DMX Address, Threshold, Fade Time, long press "UP", the value will increase rapidly
DOWN	Move down the cursor; change the status of the option; when setting DMX Address, Threshold, Fade Time, long press "DOWN", the value will decrease rapidly

Control Mode

1. EU-BUS Mode

In the current mode, the output signal is controlled by EU-BUS command, the upper computer can scan the device, and assign the address, read the parameters, and the device can operate according to the instruction of the upper computer.

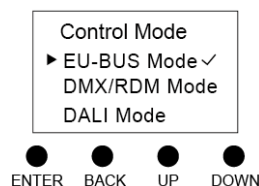

Figure 4

2. DMX mode

In the current mode, the output signal is controlled by DMX/RDM.

When using DMX512(1990) protocol, press "Enter", then set DMX address for each channel . The value can be set from 1 to 511. The addresses of 4 channels can be continuous or discontinuous, such as 1, 2, 3, 4, or 1, 5, 8, 9. That is to say, the addresses of the 4 channels are independent, but for any channel, the addresses of relay switch channel and the corresponding 0-10V DC channel are the same. In addition ,the addresses of 4 channels can be the same, so that they can be controlled simultaneously.

When using RDM(2009), the upper computer can scan the device, and assign the address, read the parameters.

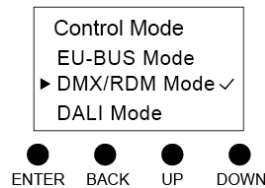

Figure 5

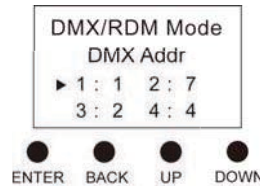

Figure 6

3. DALI mode

The output signal is controlled by the DALI command in this mode. The address of the DALI mode is defined by the system itself or modified by the host computer. Press “ENTER” to read the short addresses of 4 channels, The addresses of 4 circuits are independent of each other, but the address of each relay switch is the same as the corresponding 0-10V DC channel.

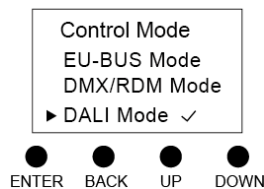

Figure 7

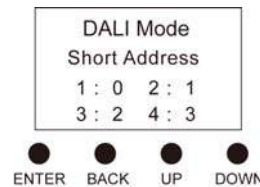

Figure 8

3. Manual mode

In the current mode, you can manually turn on or off relay switch signal, and can also set the brightness of the lamp controlled by the 0-10V signal, range of 0-100%.

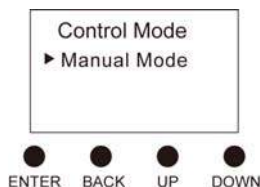

Figure 9



Figure 10

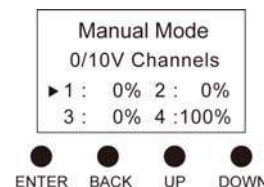

Figure 11

Output mode

1. Fade Time (note1)

In the current mode, set fade time of each channel. The range is 0-60.9s.



Figure 12

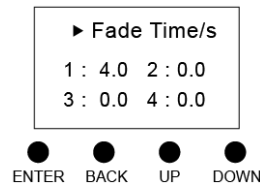

Figure 13

2. Threshold (note2)

You can set the switch threshold for each relay switch channel. When the received brightness value is more than or equal to the threshold value, open the output, or else shut down the output. The setting range of brightness threshold value is 0-100%, corresponding to the brightness level of 0-255. Threshold settings is invalid for the 0-10V channels, the 0-10V channel will output according to the received brightness value.

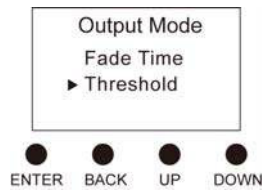

Figure 14

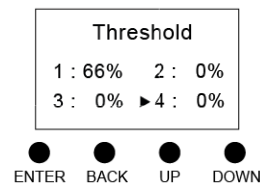

Figure 15

Time Event

1. All Event

Set all the events are valid or invalid.

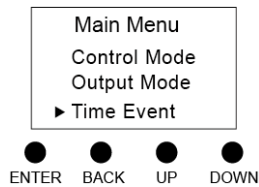

Figure 16

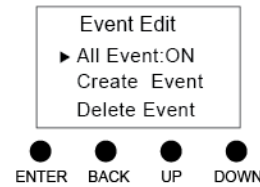

Figure 17

2. Create Event

Press “ENTER” to create event, you can set if this event is valid, and the task of the event ,the trigger time.

2.1 Event

Set whether this event is valid. Only All Event and Event are valid, the event will be triggered.

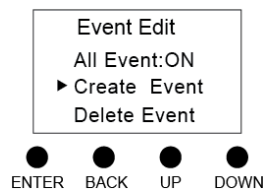

Figure 18



Figure 19

2.2 Task

Set tasks that will be triggered, turn on or off the relay switch signal or 0-10V output.



Figure 20

2.3 Event Channel

Select the channel to be triggered, you can choose one or more channels. Can choose, and the relay switch channel and 0-10V channel are independent.

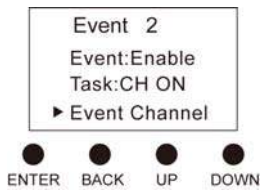

Figure 21

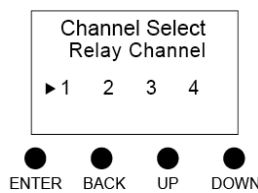

Figure 22

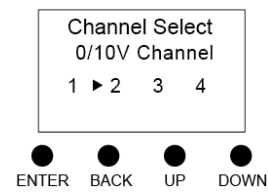

Figure 23

2.4 Event Time

Set the time to trigger events, including the month, day, week, hour, minute, second.

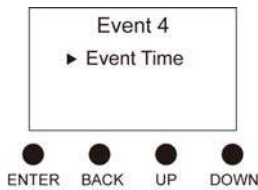

Figure 24



Figure 25



Figure 26

When the event is created, the system automatically names and saves the event, followed by 1,2,3,..... System can save up to 8 events.

3. Delete Event

Press “ENTER” to enter the delete event mode, you can cancel the event that has been set up.

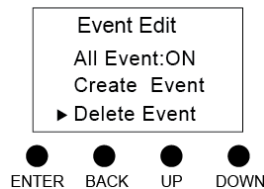

Figure 27

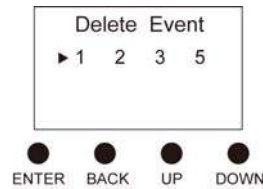

Figure 28

4. Event Manage

Press “ENTER” to enter the event management mode, you can view and modify the event has been set up.

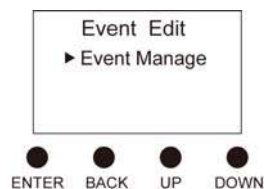

Figure 29

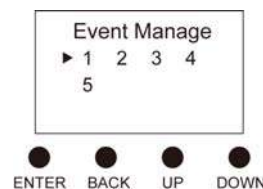

Figure 30

System Setting

After entering the system settings, you can set the current time of the system, the light of the backlight and restore the factory settings.

1. Time Setting

You can set the current time of the system.

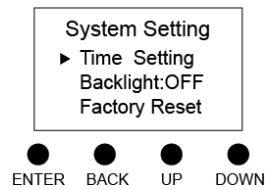

Figure 31



Figure 32

2. Backlight

When the backlight is set to "ON", the display unattended operation over 30s, LCD will enter the clock mode, showing the current date and time. After 60s, the system will automatically enter the sleep mode, press any key to end the sleep mode, enter the setting state. When the backlight is set to "OFF", the display will remain the current setting state.

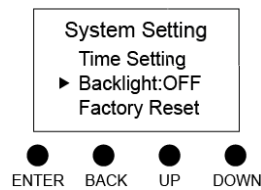

Figure 33

3. Factory Reset

Press ENTER to choose whether to reset factory settings.

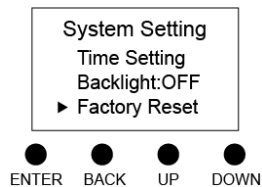

Figure 34

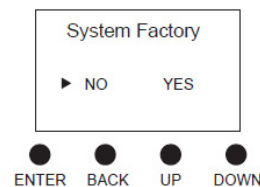

Figure 35

System Info

In this mode, the current system information can be displayed, as follows:

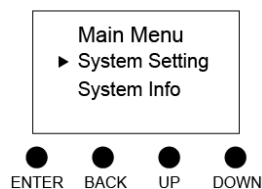

Figure 36

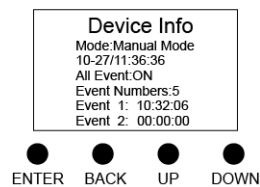

Figure 37

Line 2	control mode
Line 3	current date and time
Line 4	All Event state
Line 5	events number
Others	event name, event status or time

Manual switch

4 channel relay switch signal output, each channel corresponds to a button, you can open or close the relay switch channel output manually.

Wiring Diagram

The maximum current of each channel of 0-10V is 20mA, the maximum number of 0-10V dimming driver which can be connected to each channel is determined by signal interface current consumption. When the signal current is not enough, you can use 0-10V signal converter to amplify the power, numerous dimming driver can be connected theoretically.

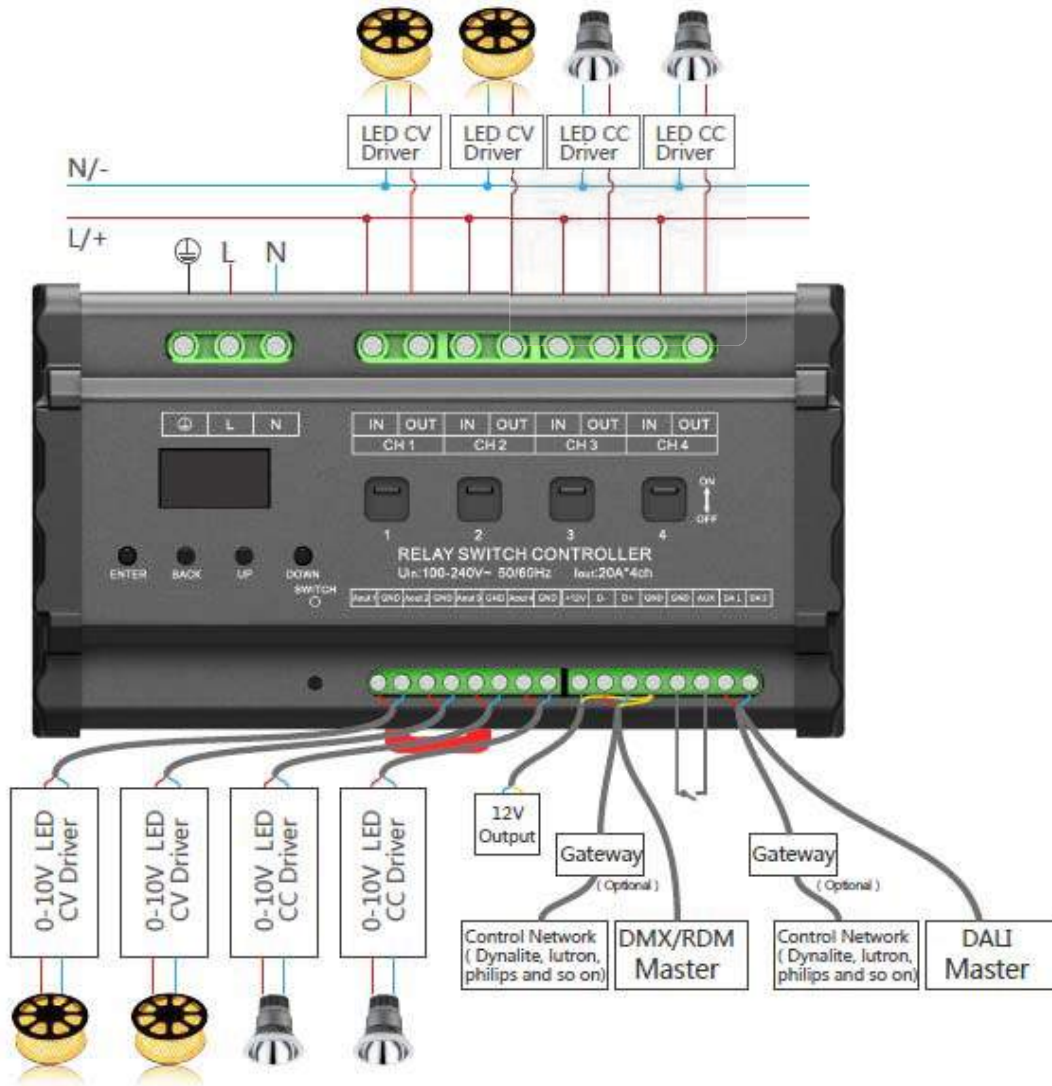

Figure 38

Note 1: Fade Time settings are valid only in DMX/RDM mode.

Note 2: Threshold settings are valid only in DMX/RDM and DALI mode.

Event Case

The following example details the event settings. For example, the relay switch channel 1 and 0-10V channel 2,4 open the output at 8:00pm on August 5th and from Monday to Friday. The setting method is as follows:

1. Set All Event to ON by pressing “ENTER”

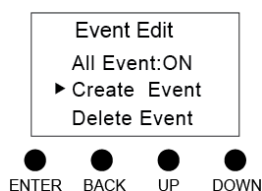

Figure 39

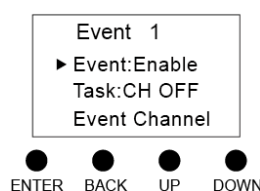

Figure 40

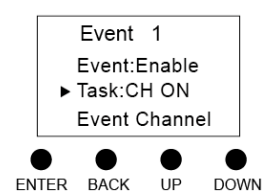

Figure 41

2. Enter the Create Event, set Event to Enable by pressing “ENTER”
3. Press “DOWN” to enter Task, set Task to CH ON by pressing “ENTER”
4. Press “DOWN” to enter Event Channel ,select the event channel, then, press “BACK” button to return

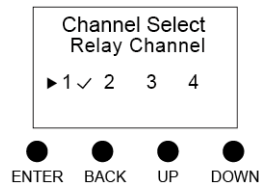

Figure 42

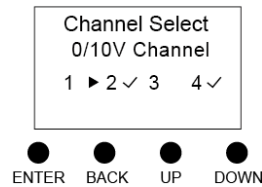

Figure 43

5. Enter the Event Time, set the trigger time, then, press “BACK” button to return

- ◆ Hour,minute,second:20:00:00

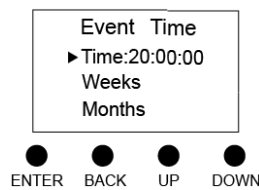

Figure 44

- ◆ Weeks :from Monday to Friday

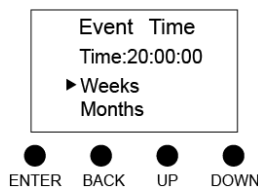

Figure 45

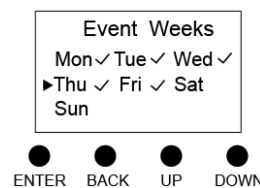

Figure 46

- ◆ Months: August

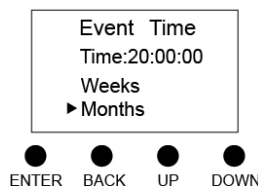

Figure 47

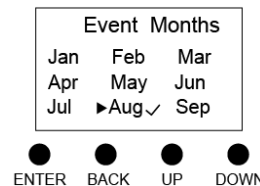

Figure 48

- ◆ Dates:5th

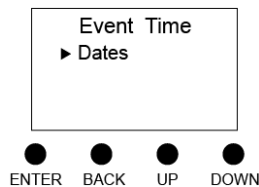

Figure 49

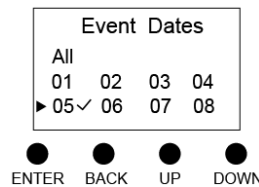

Figure 50

6. After setting up, the system automatically saves and named Event1
7. Enter the Event Manage to check or modify the event settings